

User's manual

EN

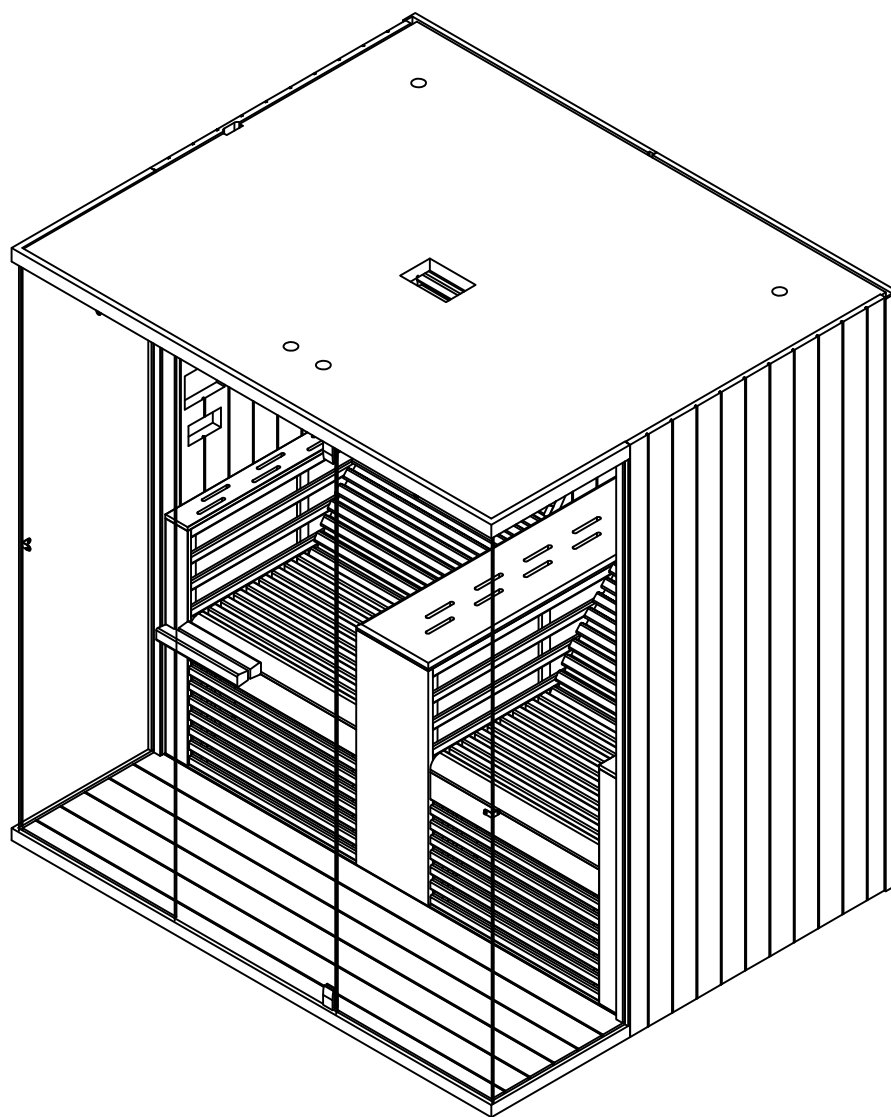

ARON 180

PREFACE

Thank you very much for purchasing our product.

Please read this manual carefully before assembling and save it afterwards. Please write down the control box serial number of the cabin as this number will be required in case of repair or order of spare parts.

ATTENTION

Installation and repair should only be done by a qualified electrician!

Check power supply rating and make sure the grounded outlet is correctly connected before installation.

Use original parts only. Do not share the outlet with any other appliances.

When not in use, turn off the cabin's power unit.

Locate your cabin indoors and on a flat, level and dry surface. A protective cover for the Sauna is required.

DANGER

Covering the heaters causes a fire hazard due to overheating. Do not cover the heaters !

Keep flammable or easily combustible materials/objects (eg.towels) away from the heater at all times.

Do not touch the heater during and shortly after use as a burning hazard exists due to hot parts.

The light bulb heats in use. If the bulb needs to be changed, unplug the cabin and let the bulb cool down before changing it.

Should the electrical connection get damaged, it must be replaced-either by the manufacturer or by a licensed electrician!

WARNING

If you suffer from illness or other health-related problems, especially heart conditions or circulatory disturbances or if you take medication, you should consult a doctor before using the Sauna.

Children and frail persons should never be in the cabin without supervision.











If you feel uncomfortable while using the Sauna, stop immediately and consult with your doctor.

Never go to a hot Sauna if you have taken alcohol, strong medicines or narcotics.

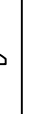
Technical data

Model	CARBON 180	
Cabin material	Spruce wood	
Depth	1800mm	
Width	1500mm	
Height	1900mm	
Voltage	AC230V	
Radiators	Type	Carbon panel&tube radiato
	Total output	3220W 14A

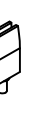
Hardware parts (variations possible)

													
Ø4x45	Ø4x70	Ø3*16	Ø4x12	Ø6x50	Ø4x12	HEX CAP NUTS	Pad	Cap	Wood pad				
49x	22x	1x	10x	2x	10x	12x	2x	2x	2x	2x	1x	2x	2x

ASSEMBLE INSTRUCTIONS

Assemble tips

Please remove transport packaging and inspect that your infrared cabin has been delivered complete and intact before beginning assemble.

A least 2 persons are required for assemble of the cabin.

Please check the countersink and hole diameter of the drill holes to avoid damaging the wood.





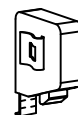
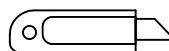
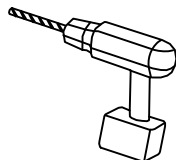
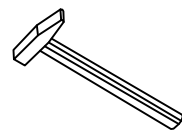
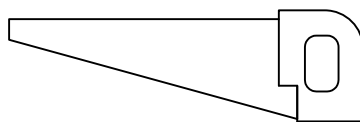
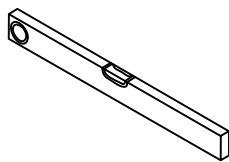



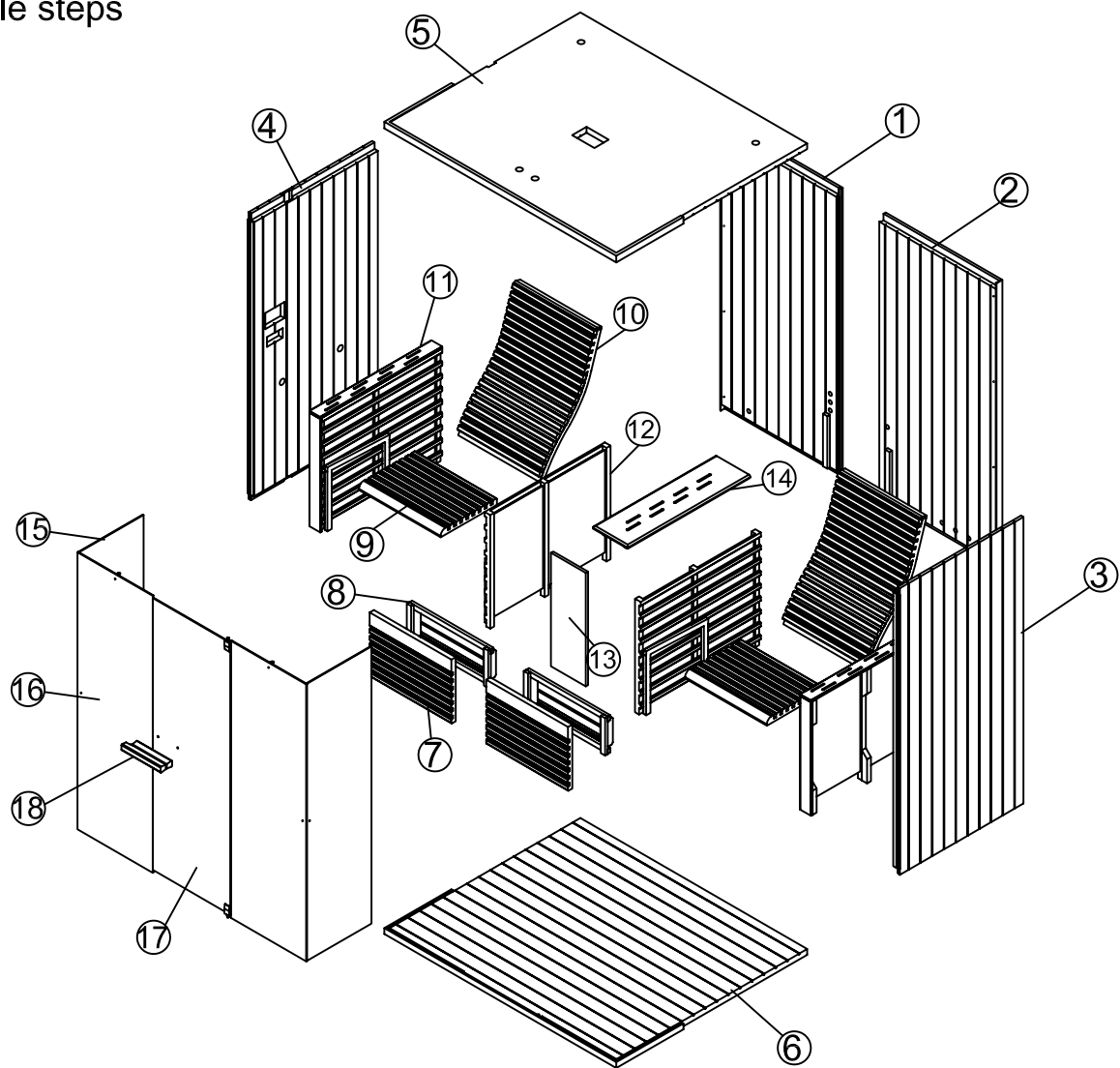

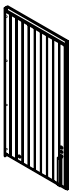
The minimum room height required for installation is 2020mm

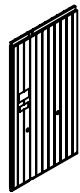
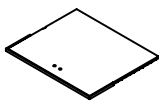
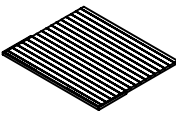
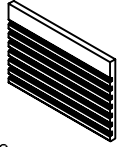
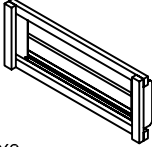
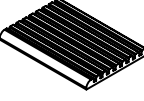
Tools

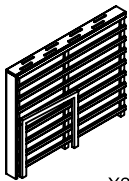
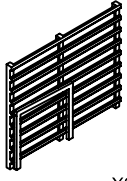

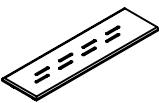
Assemble steps



								
X1	X1	X1	X1	X1	X1	X2	X2	X2
1900*896*41MM	1900*904*44MM	1900*953*44MM	1900*953*44MM	1777*1481*39MM	1777*1481*44	626*425*33MM	624*248*40MM	626*430*45MM
								
X2	X2	X2	X1	X1	X2	X2	X1	X2
974*624*98MM	934*766*83MM	921*753*33MM	753*267*17MM	939*267*17MM	1837*492*6MM	1837*577*6MM	1803*594*6MM	180*40*40MM

Assemble steps

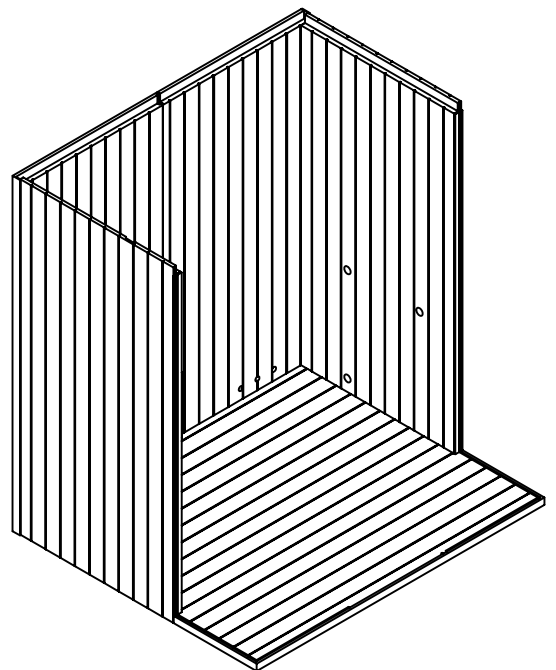
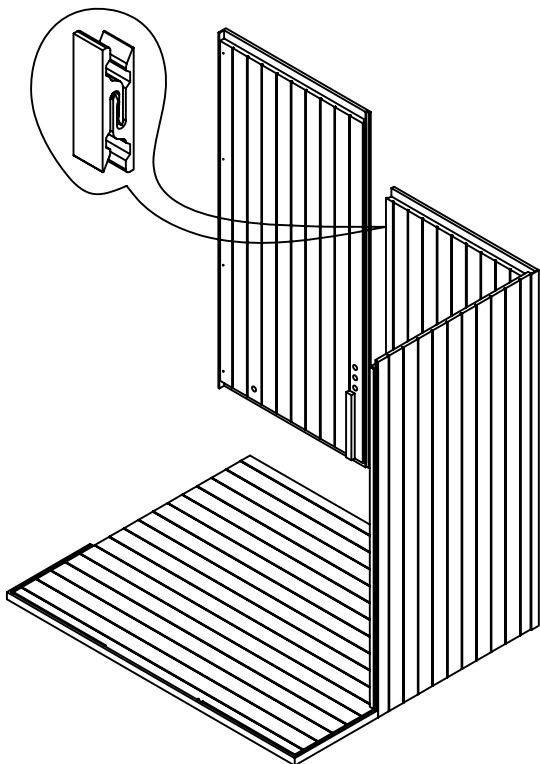
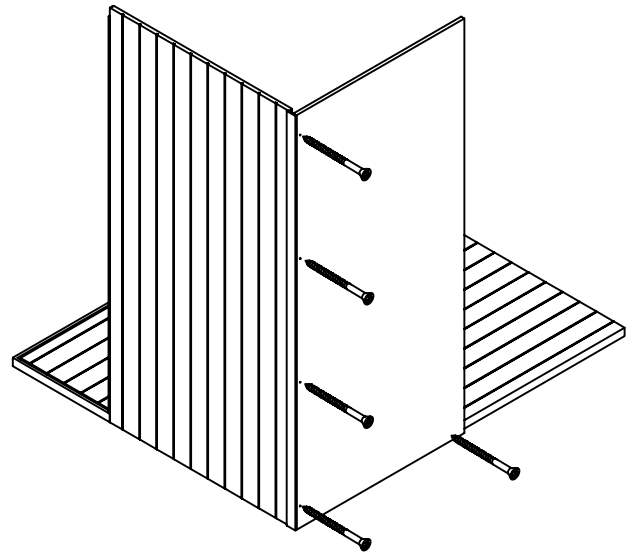
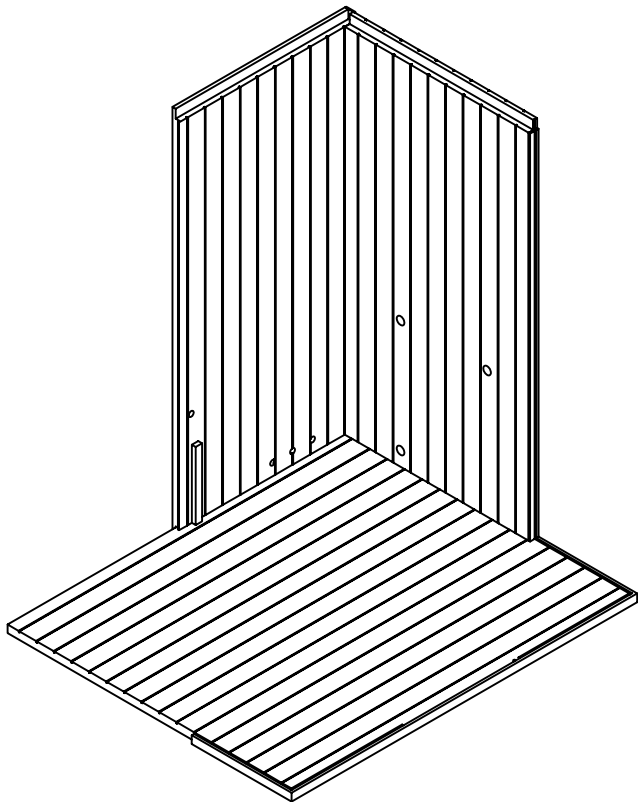

Assemble steps

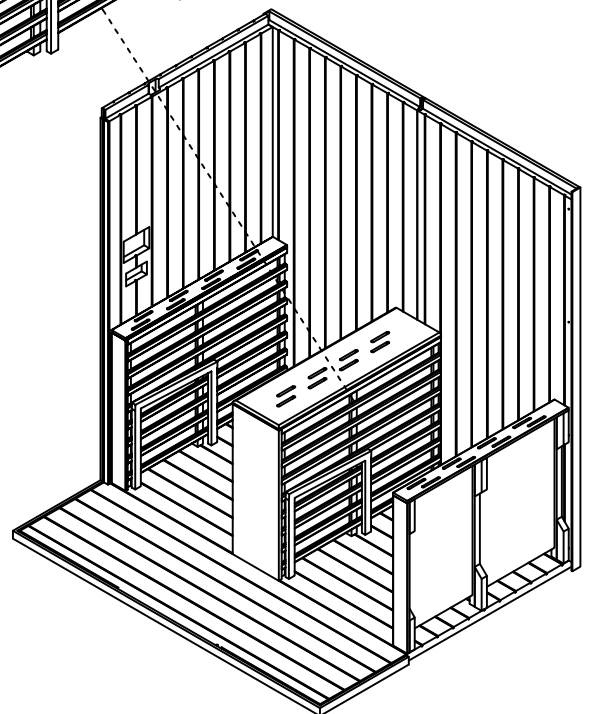
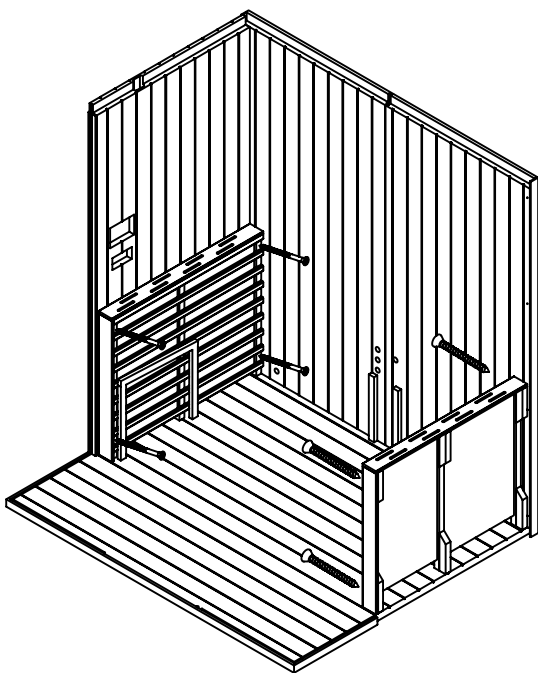
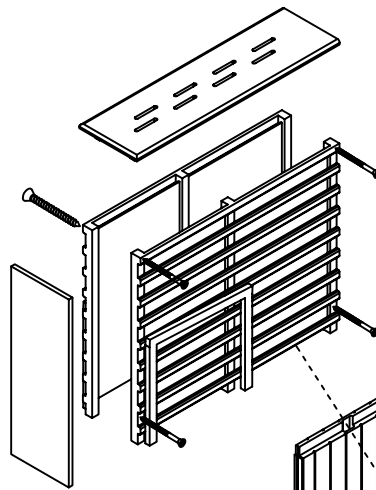
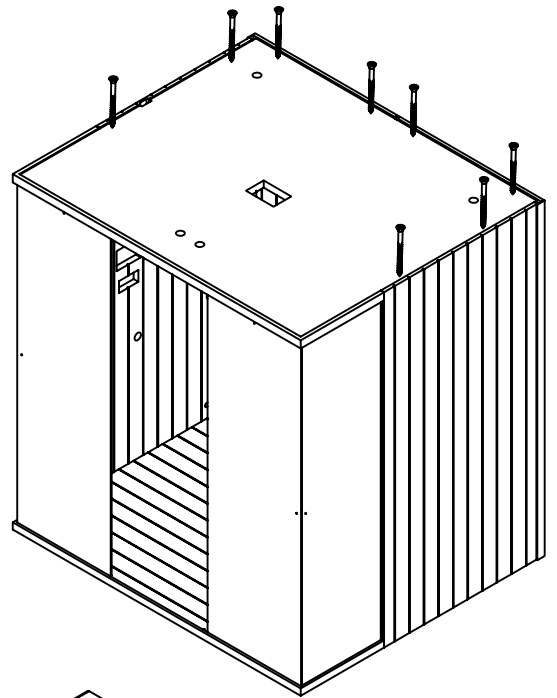
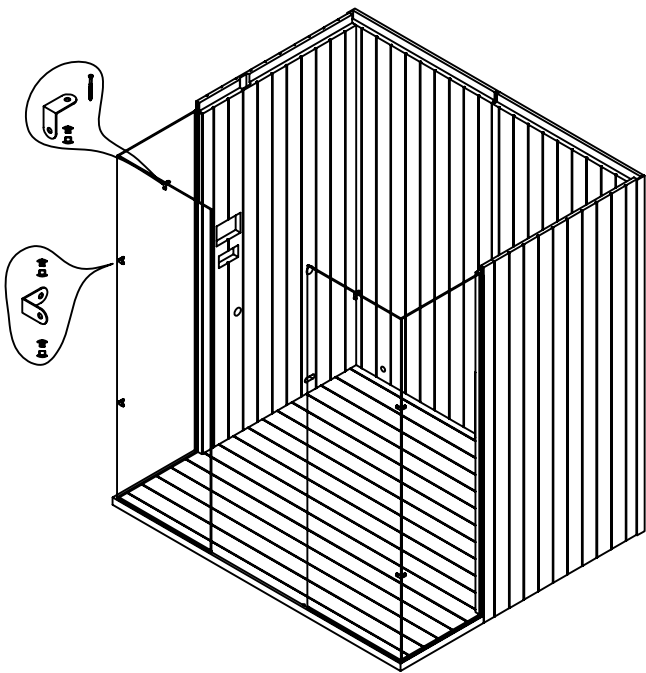

Assemble steps

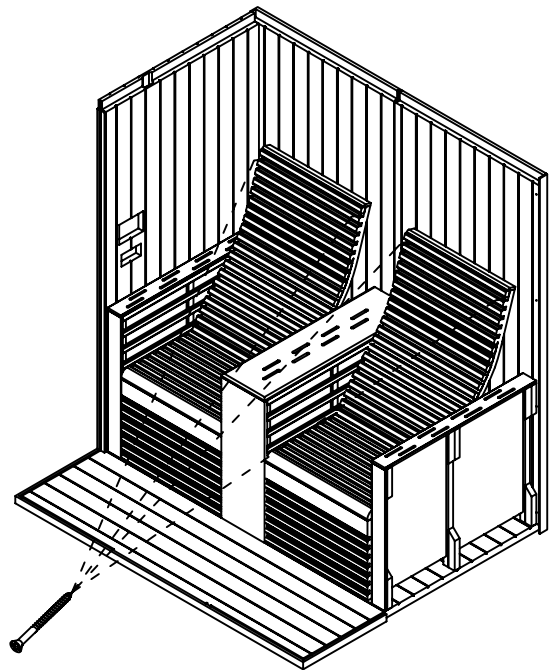
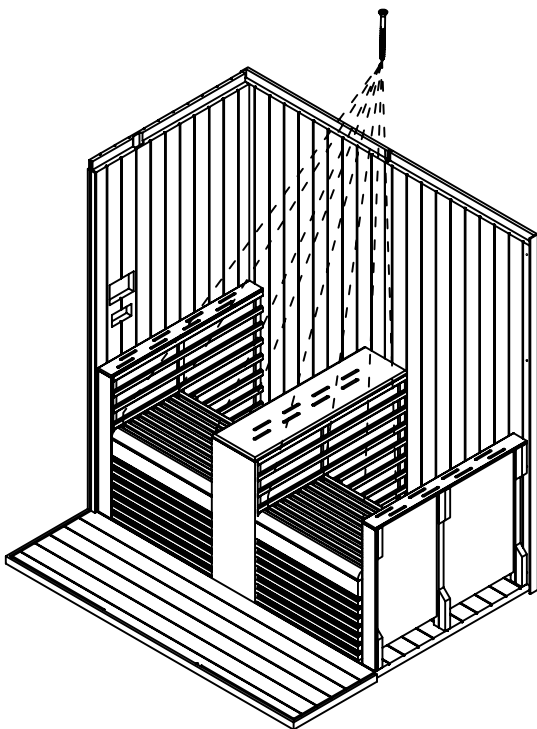
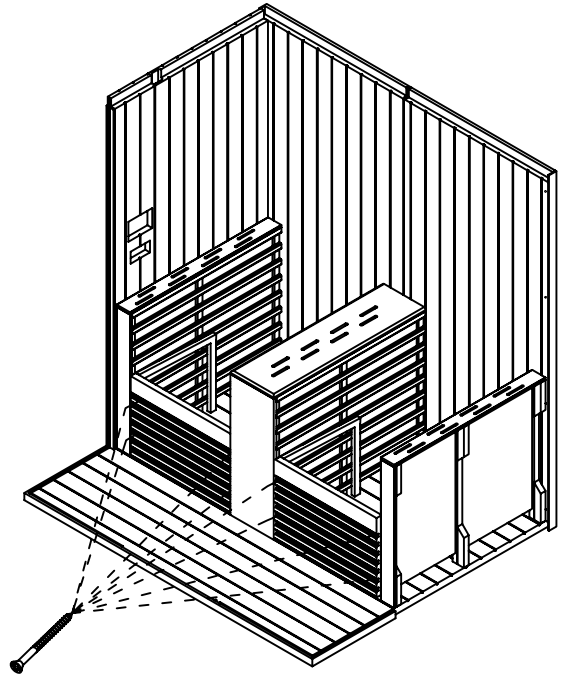
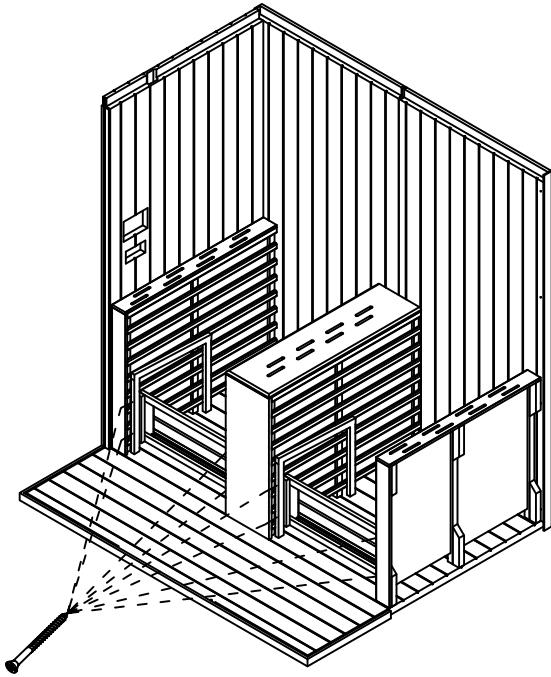

Assemble steps

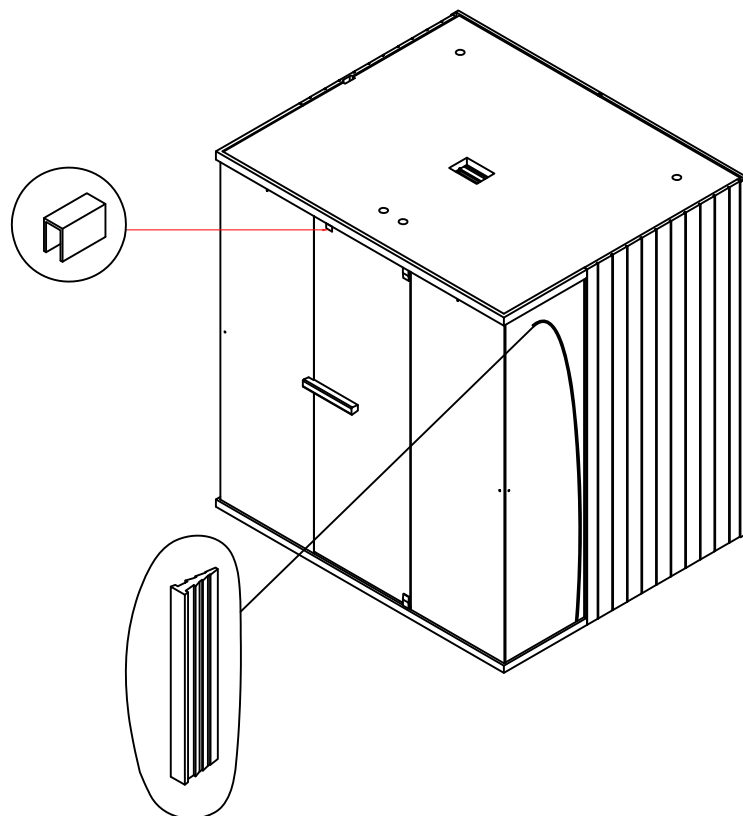
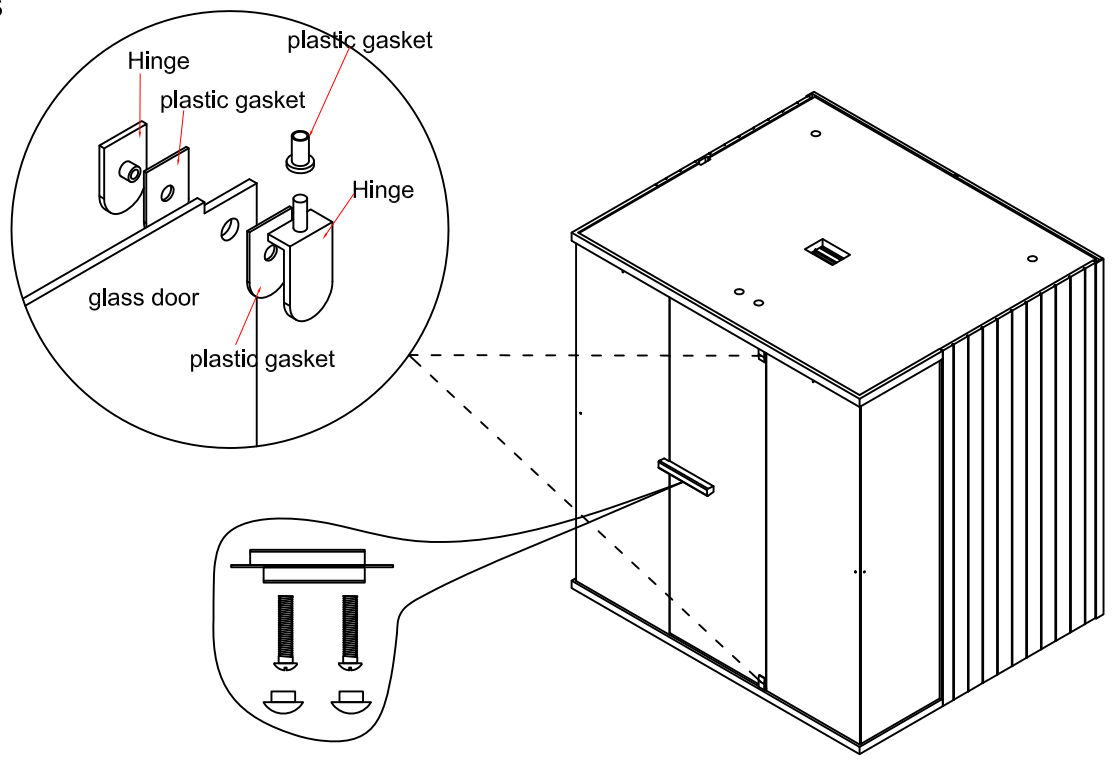

Wiring diagram

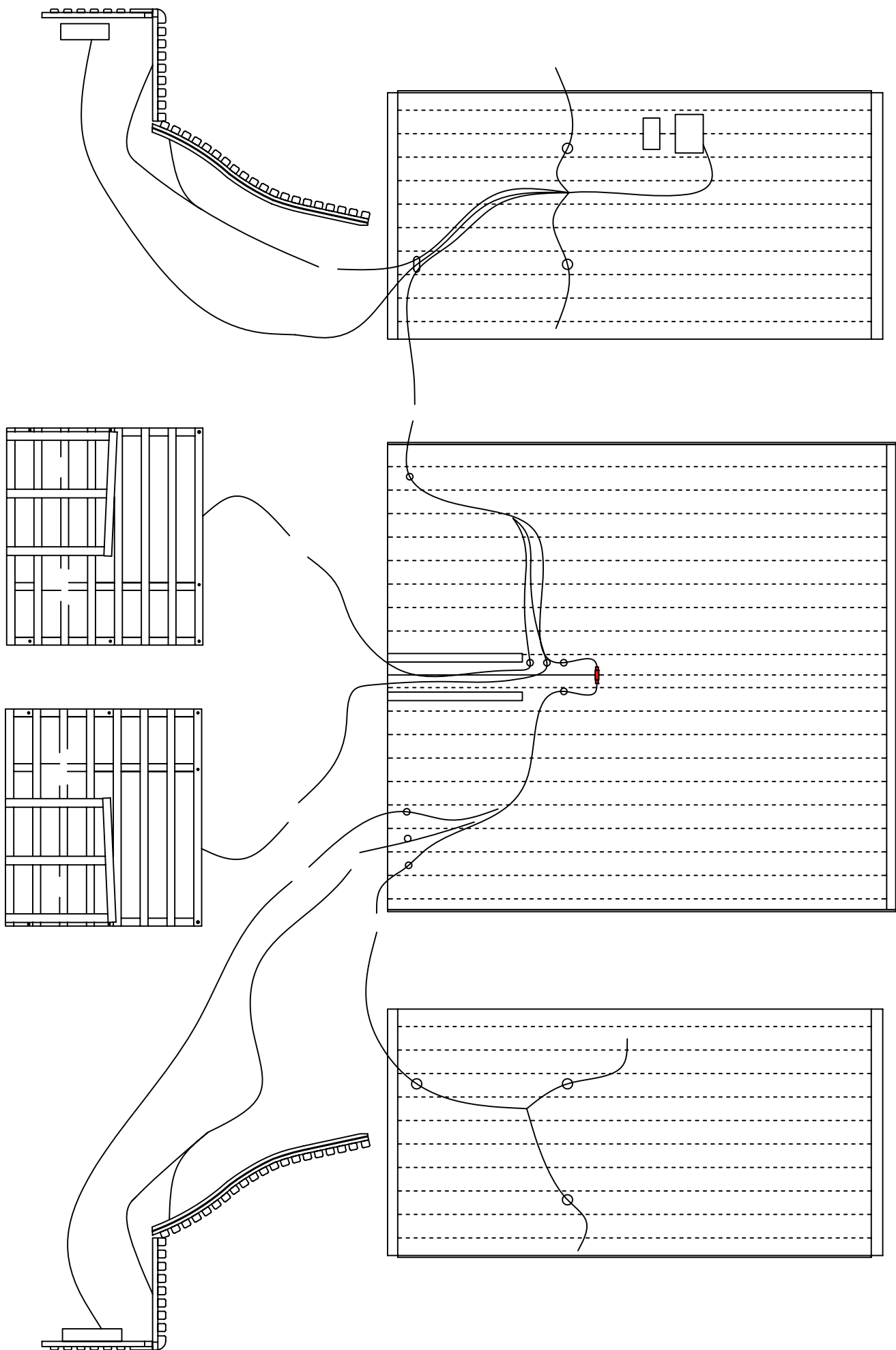

Assemble steps

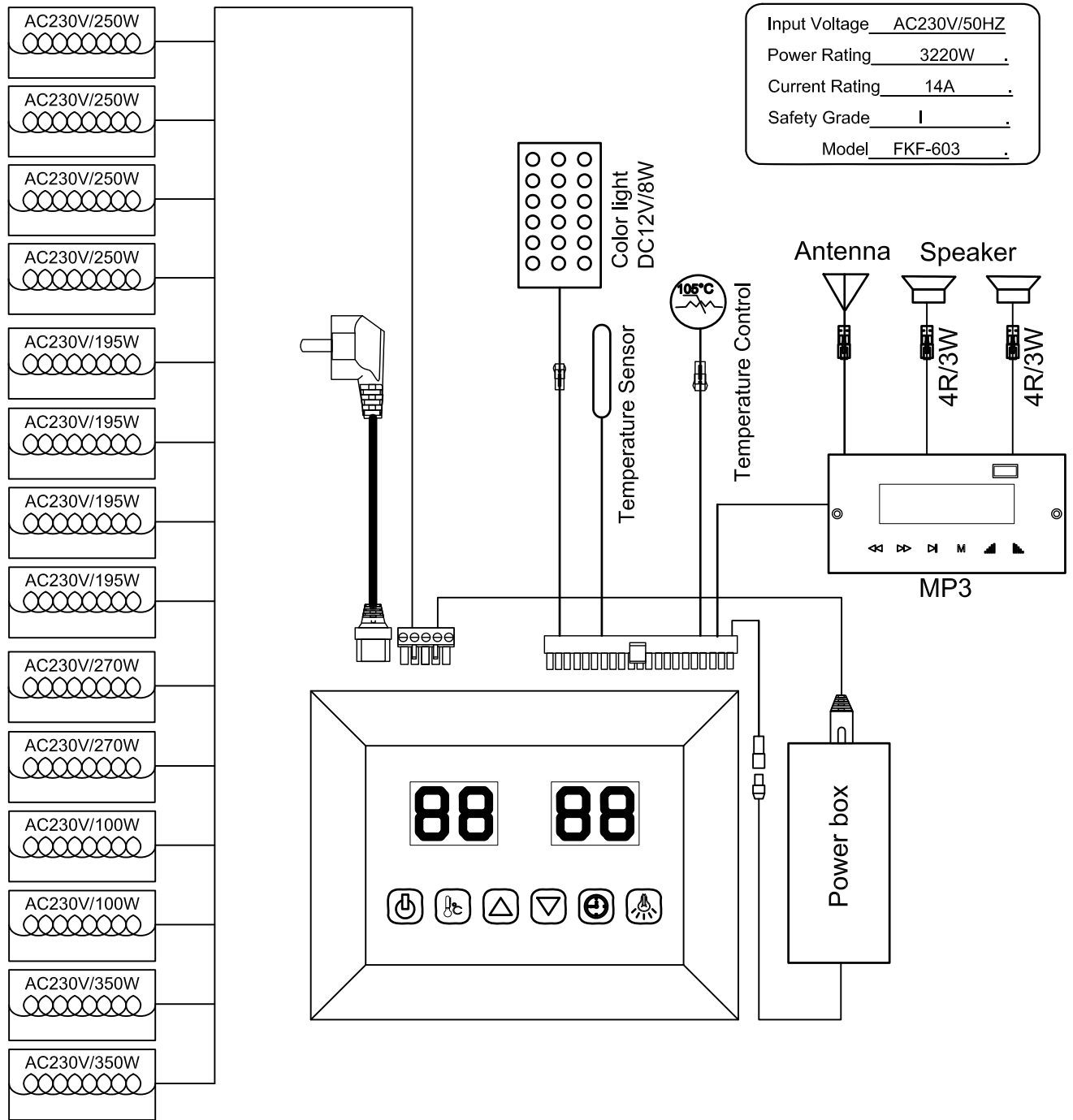

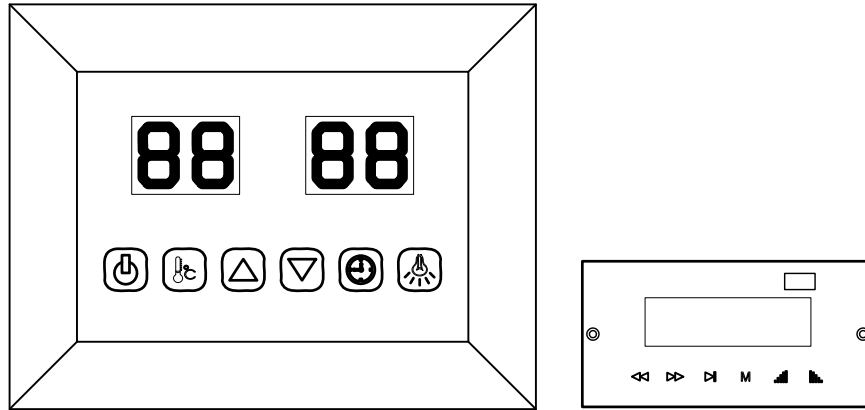

OPERATING INSTRUCTIONS





Connect the power unit to wall outlet, the LED indicator will start to blink on the display. Now it is possible to switch on the infrared heaters, the light and the music function.

1)Startup



Press  to switch on the display and heaters start to work, the length of time is automatically set to 99 minutes and the air temperature inside the cabin will be presented. Press  again could switch off the heaters.

2)Temperature settings



The left display refers to the air temperature. Press , you can set the desired temperature from 35 to 60 by pressing the / keys, Interval=1 ; The setting number blinks 10 seconds then automatically presents the air temperature; When at this temperature, the heaters will stop working automatically; When it fall 4 below this temperature, the cabin will start up automatically.

Please note: The maximum air temperature reachable in the cabin may be lower than the desired temperature. This is dependent on the temperature outside the cabin. Default temperature=40

3)Time settings

The right display refers to the length of time. Press , you can set the desired time from 5mins to 99mins by pressing the / keys; Interval=1mins; When count down to 00, the heaters will shut off automatically. Default time=99minutes.

4)Color light

Short press , you can set the desired color(7 color totally)and close the light; Long press  to go into an automatically cycling mode,changing 7 colors every 5 seconds.

OPERATING INSTRUCTIONS

5)Mp3 player

Activate the MP3 player by pressing and holding the " **M** " button on the MP3 player. Select the preferred mode with brief repeated presses of the " **M** "button on the MP3 player.(USB, MMC CARD,Bluetooth,FM radio)

USB/SD or Bluetooth mode:

You can select songs by short pressing the ◀◀ / ▶▶ keys and adjust the volume (0-32) by long pressing the ◀◀ / ▶▶ keys. The ▶| key for pause.

FM radio mode:

Long press ▶| to search stations (87.5MHZ-108MHZ) automatically, the system will save all of them;You can select stations by short pressing the ◀◀ / ▶▶ keys and adjust the volume (0-32) by long pressing the ◀◀ / ▶▶ keys.

SERVICE

Use instructions

Drink plenty of liquids before and after use of the infrared cabin.

Dry yourself off completely.

The optimal cabin temperature for a pleasant session lies between 35 and 40 .

After a heating period of an hour at the latest, the cabin should be switched off and a heating brake of at least 30 minutes should be taken.

It is recommended to take a warm shower and relax after use.

Maintenance instructions

Clean the cabin with a damp cotton towel, dry with a clean dry towel.

Clean the glass with a window/glass cleaner and a soft cloth.

Do not pour water in the control panel or clean it with wet cloth. For cleaning purposes, use a cleaning

cloth that has been only slightly moistened with a mild soapy solvent (dish detergent).

Do not use chemical detergents to clean the cabin.

Please fasten the screws of the bench once every three months, avoid the loose or drop off.